

CREATE SOOTHING LIGHTING EFFECTS WITH THIS

DARK ACTIVATED COLOUR CHANGING NIGHT LIGHT KIT

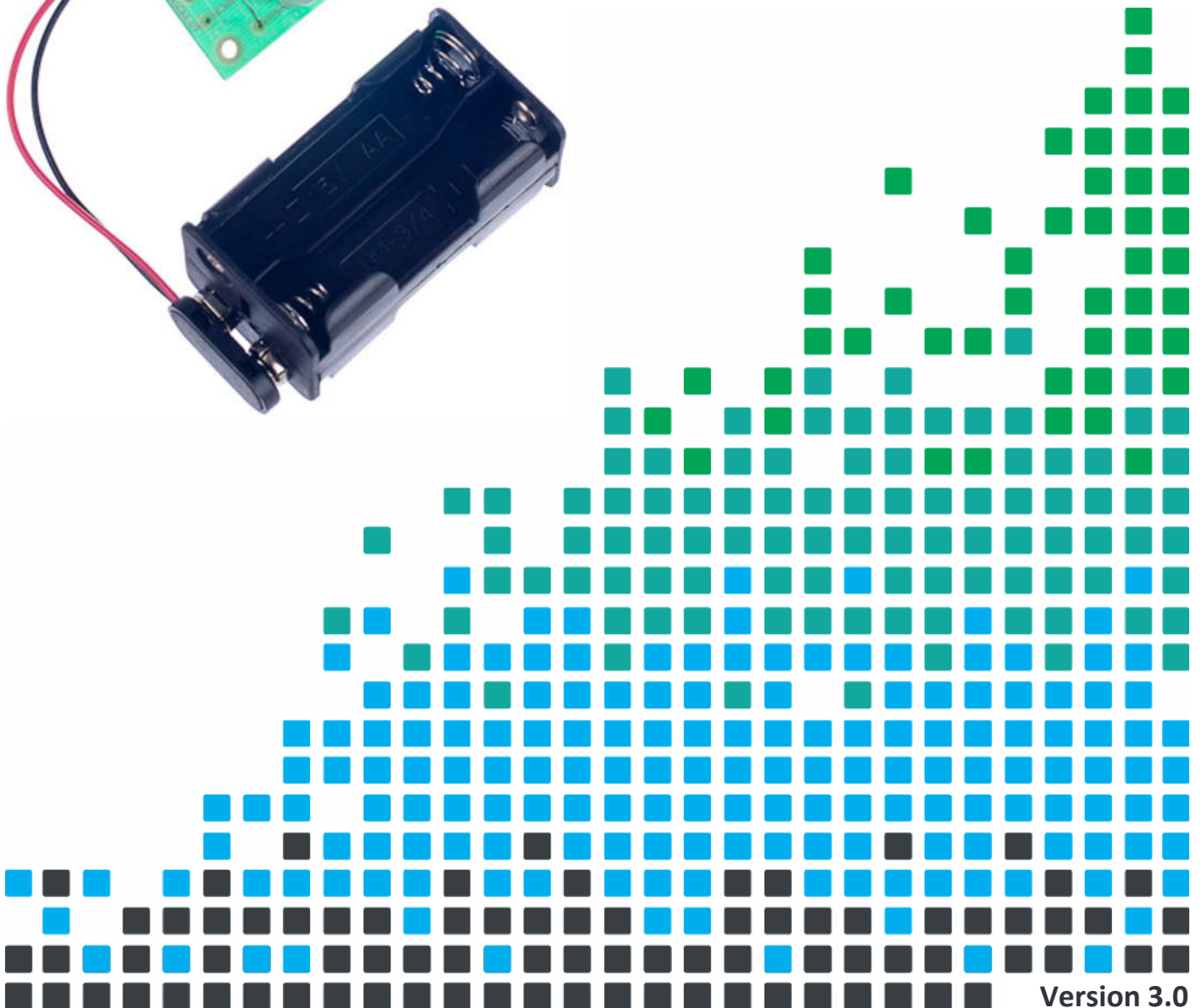
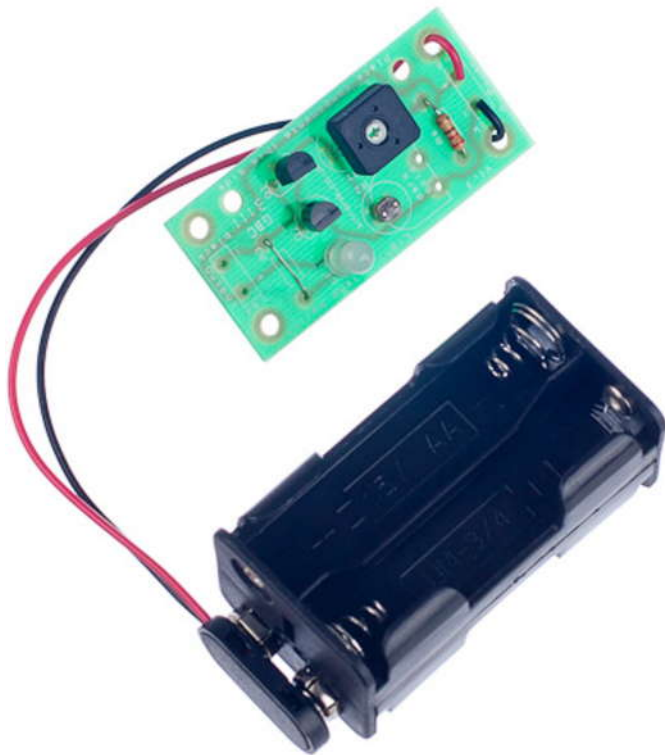

Index of Sheets

TEACHING RESOURCES

- Index of Sheets
- Introduction
- Schemes of Work
- Answers
- The Design Process
- The Design Brief
- Investigation / Research
- Developing a Specification
- Design
- Design Review (group task)
- Soldering in 8 Steps
- Resistor Values
- LEDs & Current Limit Resistors
- LEDs Continued
- Sensing Light – Photodetectors
- Using a Transistor as a Switch
- Darlington Pair
- Instruction Manual
- Evaluation
- Packaging Design

ESSENTIAL INFORMATION

- Build Instructions
- Checking Your Night Light PCB
- Testing the PCB
- Fault Finding
- Designing the Enclosure
- How the Dark Activated Switch Works
- Online Information



Introduction

About the project kit

Both the project kit and the supporting material have been carefully designed for use in KS3 Design and Technology lessons. The project kit has been designed so that even teachers with a limited knowledge of electronics should have no trouble using it as a basis from which they can form a scheme of work.

The project kits can be used in two ways:

1. As part of a larger project involving all aspects of a product design, such as designing an enclosure for the electronics to fit into.
2. On their own as a way of introducing electronics and electronic construction to students over a number of lessons.

This booklet contains a wealth of material to aid the teacher in either case.

Using the booklet

The first few pages of this booklet contains information to aid the teacher in planning their lessons and also covers worksheet answers. The rest of the booklet is designed to be printed out as classroom handouts. In most cases all of the sheets will not be needed, hence there being no page numbers, teachers can pick and choose as they see fit.

Please feel free to print any pages of this booklet to use as student handouts in conjunction with Kitronik project kits.

Support and resources

You can also find additional resources at www.kitronik.co.uk. There are component fact sheets, information on calculating resistor and capacitor values, puzzles and much more.

Kitronik provide a next day response technical assistance service via e-mail. If you have any questions regarding this kit or even suggestions for improvements, please e-mail us at:

support@kitronik.co.uk

Alternatively, phone us on 0845 8380781.



Schemes of Work

Two schemes of work are included in this pack; the first is a complete project including the design & manufacture of an enclosure for the kit (below). The second is a much shorter focused practical task covering just the assembly of the kit (next page). Equally, feel free to use the material as you see fit to develop your own schemes.

Before starting we would advise that you to build a kit yourself. This will allow you to become familiar with the project and will provide a unit to demonstrate.

Complete product design project including electronics and enclosure

Hour 1	Introduce the task using 'The Design Brief' sheet. Demonstrate a built unit. Take students through the design process using 'The Design Process' sheet. <u>Homework</u> : Collect examples of lamps and night lights. List the common features of these products on the 'Investigation / Research' sheet.
Hour 2	Develop a specification for the project using the 'Developing a Specification' sheet. <u>Resource</u> : Sample of lamps and night lights. <u>Homework</u> : Using the internet or other search method, find out what is meant by 'design for manufacture'. List five reasons why design for manufacture should be considered on any design project.
Hour 3	Read 'Designing the Enclosure' sheet. Develop a product design using the 'Design' sheet. <u>Homework</u> : Complete design.
Hour 4	Using cardboard, get the students to model their enclosure design. Allow them to make alterations to their design if the model shows any areas that need changing.
Hour 5	Split the students into groups and get them to perform a group design review using the 'Design Review' sheet.
Hour 6	Using the 'Soldering in Ten Steps' sheet, demonstrate and get students to practice soldering. Start the 'Resistor Value' worksheet. <u>Homework</u> : Complete any of the remaining resistor tasks.
Hour 7	Build the electronic kit using the 'Build Instructions'.
Hour 8	Complete the build of the electronic kit. Check the completed PCB and fault find if required using the 'Checking Your Night Light PCB' section and the fault finding flow chart. <u>Homework</u> : Read 'How the Dark Activated Switch Works' sheet in conjunction with the Sensing Light and Transistor sheets.
Hour 9	Build the enclosure. <u>Homework</u> : Collect some examples of instruction manuals.
Hour 10	Build the enclosure. <u>Homework</u> : Read 'Instruction Manual' sheet and start developing instructions for the night light.
Hour 11	Build the enclosure.
Hour 12	Using the 'Evaluation' and 'Improvement' sheet, get the students to evaluate their final product and state where improvements can be made.

Additional Work

Package design for those who complete ahead of others.



Electronics only

Hour 1	Introduction to the kit demonstrating a built unit. Using the 'Soldering in 8 Steps' sheet, practice soldering.
Hour 2	Build the kit using the 'Build Instructions'.
Hour 3	Check the completed PCB and fault find if required using 'Checking Your Night Light PCB' and fault finding flow chart.

Answers

Resistor questions

1st Band	2nd Band	Multiplier x	Value
Brown	Black	Yellow	100,000 Ω
Green	Blue	Brown	560 Ω
Brown	Grey	Yellow	180,000 Ω
Orange	White	Black	39 Ω

Value	1st Band	2nd Band	Multiplier x
180 Ω	Brown	Grey	Brown
3,900 Ω	Orange	White	Red
47,000 (47K) Ω	Yellow	Violet	Orange
1,000,000 (1M) Ω	Brown	Black	Green



The Design Process

The design process can be short or long, but will always consist of a number of steps that are the same on every project. By splitting a project into these clearly defined steps, it becomes more structured and manageable. The steps allow clear focus on a specific task before moving to the next phase of the project. A typical design process is shown on the right.

Design brief

What is the purpose or aim of the project? Why is it required and who is it for?

Investigation

Research the background of the project. What might the requirements be? Are there competitors and what are they doing? The more information found out about the problem at this stage, the better, as it may make a big difference later in the project.

Specification

This is a complete list of all the requirements that the project must fulfil - no matter how small. This will allow you to focus on specifics at the design stage and to evaluate your design. Missing a key point from a specification can result in a product that does not fulfil its required task.

Design

Develop your ideas and produce a design that meets the requirements listed in the specification. At this stage it is often normal to prototype some of your ideas to see which work and which do not.

Build

Build your design based upon the design that you have developed.

Evaluate

Does the product meet all points listed in the specification? If not, return to the design stage and make the required changes. Does it then meet all of the requirements of the design brief? If not, return to the specification stage and make improvements to the specification that will allow the product to meet these requirements and repeat from this point. It is normal to have such iterations in design projects, though you normally aim to keep these to a minimum.

Improve

Do you feel the product could be improved in any way? These improvements can be added to the design.

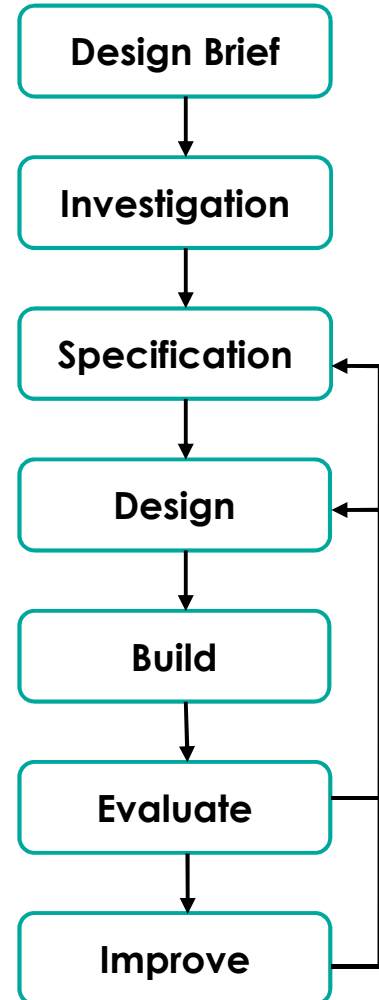

The Design Brief

A manufacturer of bedside lamps has developed a simple lamp that turns on automatically when it goes dark at night. The lamp also uses a special LED that cycles through a number of different colours when it is turned on. The circuit has been developed to the point where they have a working Printed Circuit Board (PCB).

The manufacturer would like you to design an enclosure into which the electronics can be housed. It is important that you make sure that the final design meets all the requirements that you identify for such a product. For instance, if you decide to design the lamp that is for a young child, it should meet the requirements of this type of user.

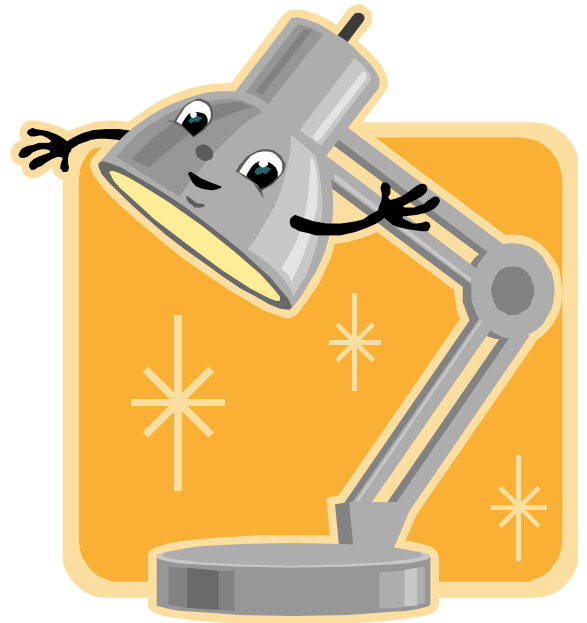

Complete Circuit

A fully built circuit is shown below.

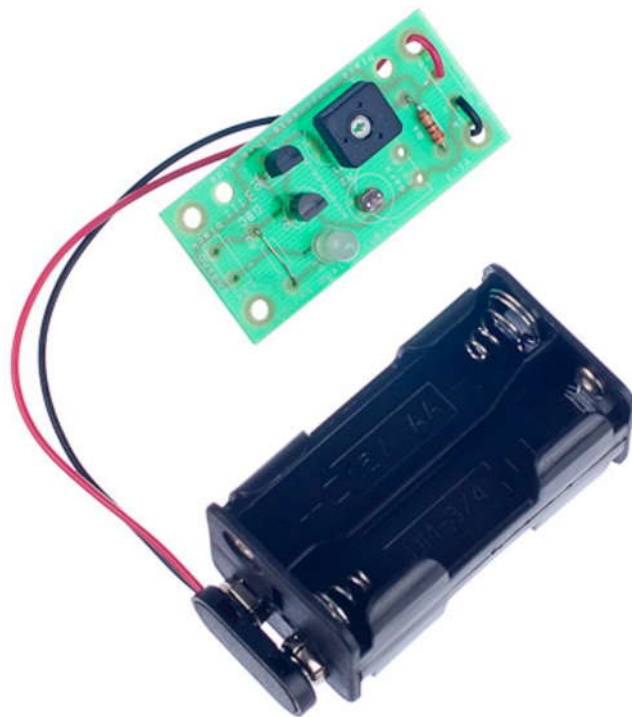

Investigation / Research

Using a number of different search methods, find examples of similar products that are already on the market. Use additional pages if required.

Name.....

Class.....



Developing a Specification

Using your research into the target market for the product, identify the key requirements for the product and explain why each of these is important.

Name.....

Class.....

Requirement	Reason
Example: The enclosure should allow easy access to the batteries.	Example: So that they can be quickly changed when they become flat.



Design

Develop your ideas to produce a design that meets the requirements listed in the specification.

Name.....

Class.....



Design Review (group task)

Split into groups of three or four. Take it in turns to review each person's design against the requirements of their specification. Also look to see if you can spot any additional aspects of each design that may cause problems with the final product. This will allow you to ensure that you have a good design and catch any faults early in the design process. Note each point that is made and the reason behind it. Decide if you are going to accept or reject the comment made. Use these points to make improvements to your initial design.

Comment	Reason for comment	Accept or Reject



Soldering in 8 Steps

1

INSERT COMPONENT

Place the component into the board, making sure that it goes in the correct way around, and the part sits closely against the board. Bend the legs slightly to secure the part. Place the board so you can access the pads with a soldering iron.

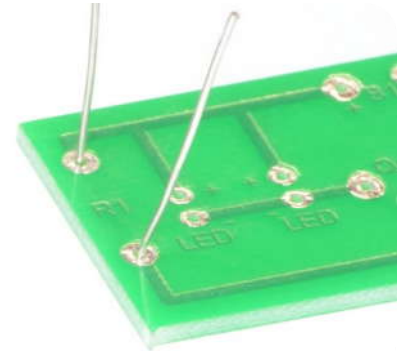

2

CLEAN SOLDERING IRON

Make sure the soldering iron has warmed up. If necessary use a brass soldering iron cleaner or damp sponge to clean the tip.



3

PICKUP IRON AND SOLDER

Pick up the Soldering Iron in one hand, and the solder in the other hand.

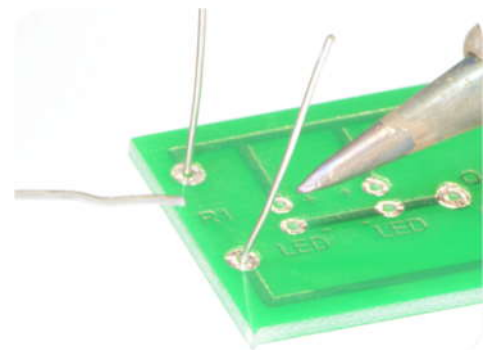

4

HEAT PAD

Place soldering iron tip on the pad.

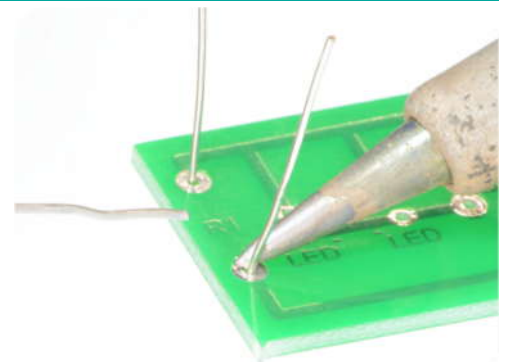

5

APPLY SOLDER

Feed a small amount of solder into the joint. The solder should melt on the pad and flow around the component leg.

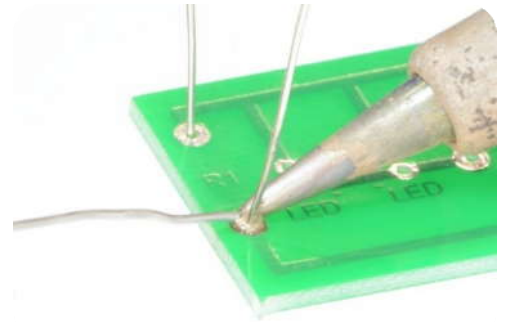

6

STOP SOLDERING

Remove the solder, and then remove the soldering iron.

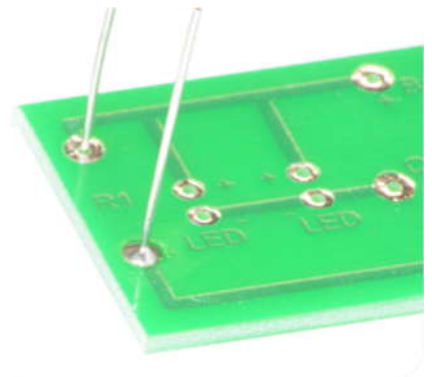

7

TRIM EXCESS

Leave the joint to cool for a few seconds, then using a pair of cutters trim the excess component lead.

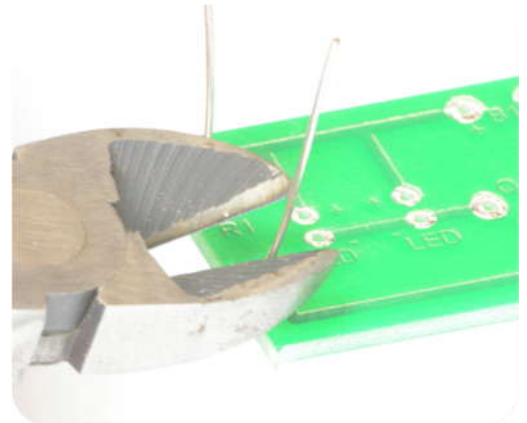

8

REPEAT

Repeat this process for each solder joint required.

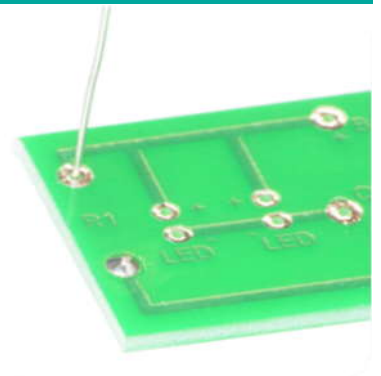

Resistor Values

A resistor is a device that opposes the flow of electrical current. The bigger the value of a resistor, the more it opposes the current flow. The value of a resistor is given in Ω (ohms) and is often referred to as its 'resistance'.

Identifying resistor values

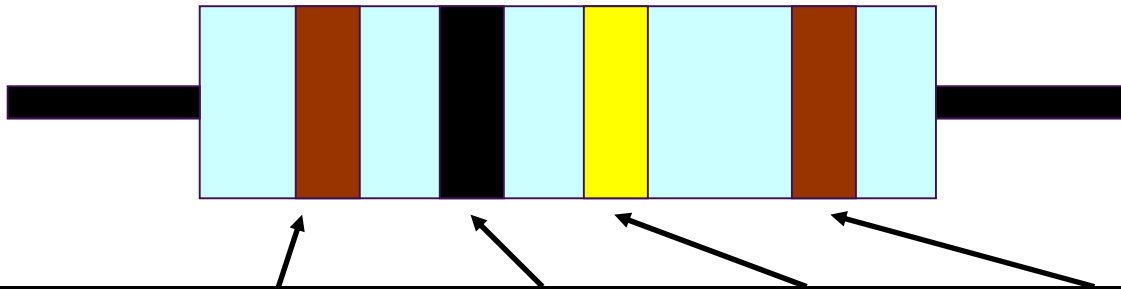

Band Colour	1st Band	2nd Band	Multiplier x	Tolerance
Silver			$\div 100$	10%
Gold			$\div 10$	5%
Black	0	0	1	
Brown	1	1	10	1%
Red	2	2	100	2%
Orange	3	3	1000	
Yellow	4	4	10,000	
Green	5	5	100,000	
Blue	6	6	1,000,000	
Violet	7	7		
Grey	8	8		
White	9	9		

Example: Band 1 = Red, Band 2 = Violet, Band 3 = Orange, Band 4 = Gold

The value of this resistor would be:

$$\begin{aligned}
 &2 \text{ (Red)} \ 7 \text{ (Violet)} \times 1,000 \text{ (Orange)} &&= 27 \times 1,000 \\
 &&&= \mathbf{27,000} \text{ with a 5\% tolerance (gold)} \\
 &&&= \mathbf{27K\Omega}
 \end{aligned}$$

Too many zeros?

Kilo ohms and mega ohms can be used:

$$1,000\Omega = 1K$$

$$1,000K = 1M$$

Resistor identification task

Calculate the resistor values given by the bands shown below. The tolerance band has been ignored.

1st Band	2nd Band	Multiplier x	Value
Brown	Black	Yellow	
Green	Blue	Brown	
Brown	Grey	Yellow	
Orange	White	Black	



Calculating resistor markings

Calculate what the colour bands would be for the following resistor values.

Value	1st Band	2nd Band	Multiplier x
180 Ω			
3,900 Ω			
47,000 (47K) Ω			
1,000,000 (1M) Ω			

What does tolerance mean?

Resistors always have a tolerance but what does this mean? It refers to the accuracy to which it has been manufactured. For example if you were to measure the resistance of a gold tolerance resistor you can guarantee that the value measured will be within 5% of its stated value. Tolerances are important if the accuracy of a resistors value is critical to a design's performance.

Preferred values

There are a number of different ranges of values for resistors. Two of the most popular are the E12 and E24. They take into account the manufacturing tolerance and are chosen such that there is a minimum overlap between the upper possible value of the first value in the series and the lowest possible value of the next. Hence there are fewer values in the 10% tolerance range.

E-12 resistance tolerance ($\pm 10\%$)											
10	12	15	18	22	27	33	39	47	56	68	82

E-24 resistance tolerance ($\pm 5\%$)											
10	11	12	13	15	16	18	20	22	24	27	30
33	36	39	43	47	51	56	62	68	75	82	91



LEDs & Current Limit Resistors

Before we look at LEDs, we first need to start with diodes. Diodes are used to control the direction of flow of electricity. In one direction they allow the current to flow through the diode, in the other direction the current is blocked.

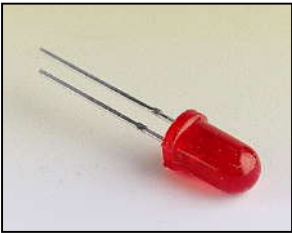

An LED is a special diode. LED stands for Light Emitting Diode. LEDs are like normal diodes, in that they only allow current to flow in one direction, however when the current is flowing the LED lights.

The symbol for an LED is the same as the diode but with the addition of two arrows to show that there is light coming from the diode. As the LED only allows current to flow in one direction, it's important that we can work out which way the electricity will flow. This is indicated by a flat edge on the LED.

For an LED to light properly, the amount of current that flows through it needs to be controlled. To do this we use a current limit resistor. If we didn't use a current limit resistor the LED would be very bright for a short amount of time, before being permanently destroyed.

To work out the best resistor value we need to use Ohms Law. This connects the voltage across a device and the current flowing through it to its resistance.

Ohms Law tells us that the flow of current (I) in a circuit is given by the voltage (V) across the circuit divided by the resistance (R) of the circuit.

$$I = \frac{V}{R}$$

Like diodes, LEDs drop some voltage across them: typically 1.8 volts for a standard LED. However the high brightness LED used in the 'white light' version of the lamp drops 3.5 volts.

The USB lamp runs off the 5V supply provided by the USB connection so there must be a total of 5 volts dropped across the LED (V_{LED}) and the resistor (V_R). As the LED manufacturer's datasheet tells us that there is 3.5 volts dropped across the LED, there must be 1.5 volts dropped across the resistor. ($V_{LED} + V_R = 3.5 + 1.5 = 5V$).

LEDs normally need about 10mA to operate at a good brightness. Since we know that the voltage across the current limit resistor is 1.5 volts and we know that the current flowing through it is 0.01 Amps, the resistor can be calculated.

Using Ohms Law in a slightly rearranged format:

$$R = \frac{V}{I} = \frac{1.5}{0.01} = 150\Omega$$

Hence we need a 150Ω current limit resistor.

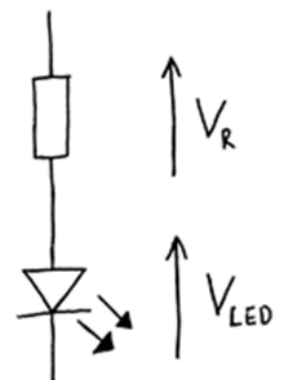

LEDs Continued

The Colour Changing LEDs used in the 'colour' version of the lamp has the current limit resistor built into the LED itself. Therefore no current limit resistor is required. Because of this, a 'zero Ω ' resistor is used to connect the voltage supply of 5V directly to the Colour Changing LED.

Packages

LEDs are available in many shapes and sizes. The 5mm round LED is the most common. The colour of the plastic lens is often the same as the actual colour of light emitted – but not always with high brightness LEDs.

Advantages of using LEDs over bulbs

Some of the advantages of using an LED over a traditional bulb are:

Power efficiency	LEDs use less power to produce the same amount of light, which means that they are more efficient. This makes them ideal for battery power applications.
Long life	LEDs have a very long life when compared to normal light bulbs. They also fail by gradually dimming over time instead of a sharp burn out.
Low temperature	Due to the higher efficiency of LEDs, they can run much cooler than a bulb.
Hard to break	LEDs are much more resistant to mechanical shock, making them more difficult to break than a bulb.
Small	LEDs can be made very small. This allows them to be used in many applications, which would not be possible with a bulb.
Fast turn on	LEDs can light up faster than normal light bulbs, making them ideal for use in car brake lights.

Disadvantages of using LEDs

Some of the disadvantages of using an LED over a traditional bulb are:

Cost	LEDs currently cost more for the same light output than traditional bulbs. However, this needs to be balanced against the lower running cost of LEDs due to their greater efficiency.
Drive circuit	To work in the desired manner, an LED must be supplied with the correct current. This could take the form of a series resistor or a regulated power supply.
Directional	LEDs normally produce a light that is focused in one direction, which is not ideal for some applications.

Typical LED applications

Some applications that use LEDs are:

- Bicycle lights
- Car lights (brake and headlights)
- Traffic lights
- Indicator lights on consumer electronics
- Torches
- Backlights on flat screen TVs and displays
- Road signs
- Information displays
- Household lights
- Clocks



Sensing Light – Photodetectors

To sense light levels in electronics requires a component which is sensitive to light. Two types of photodetector capable of doing this are Light Dependent Resistors (LDR) and Phototransistors.

An LDR is a component that has a resistance that falls with an increase in the light intensity falling upon the device.

A Phototransistor is a transistor whose base is exposed to light, rather than being wired to a pin.

As the light level increases this activates the transistor, in a similar manner to increasing the base current of a regular transistor.

The resistance of an LDR may typically change by 4000x between Daylight and darkness.

A Phototransistor's gain varies with the amount of light it is exposed to, typically from 100 to 1500

You can see that there is a large variation between these figures depending on the light level. With appropriate circuits these changes can be used to control other electronics.

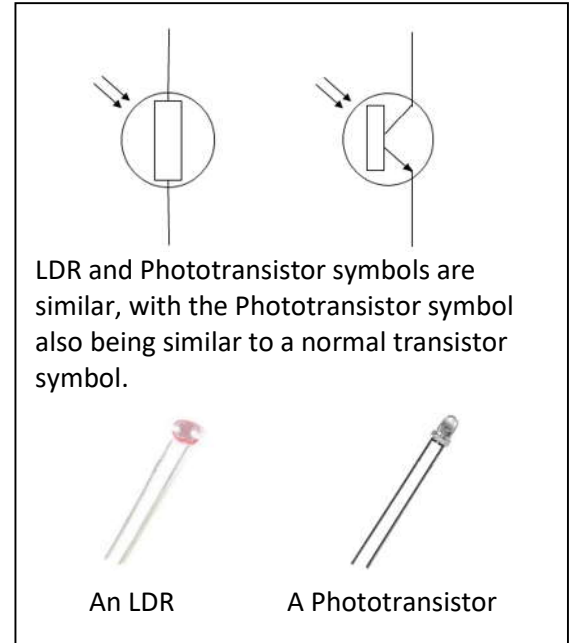

Applications

There are many applications for photodetectors. These include:

Lighting switch

The most obvious application is to automatically turn on a light at certain light level. An example of this could be a street light.

Camera shutter control

Photodetectors can be used to control the shutter speed on a camera. The photodetector would be used to measure the light intensity and then set the camera shutter speed to the appropriate level.

Example

The circuit shown right shows a simple way of constructing a circuit that turns on when it goes dark. The increase in resistance of the LDR in relation to the other resistor, which is fixed as the light intensity drops, will cause the transistor to turn on. The value of the fixed resistor will depend on the LDR used, the transistor used and the supply voltage.

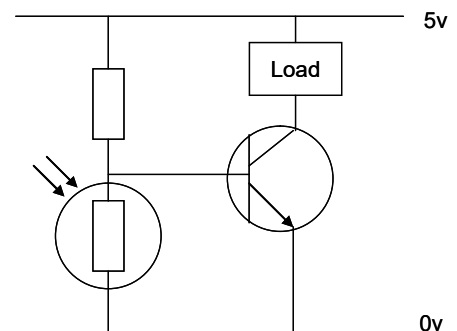

Using a Transistor as a Switch

Overview

A transistor in its simplest form is an electronic switch. It allows a small amount of current to switch a much larger amount of current either on or off. There are two types of transistors: NPN and PNP. The different order of the letters relate to the order of the N and P type material used to make the transistor. Both types are available in different power ratings, from signal transistors through to power transistors. The NPN transistor is the more common of the two and the one examined in this sheet.

Schematic symbol

The symbol for an NPN type transistor is shown to the right along with the labelled pins.

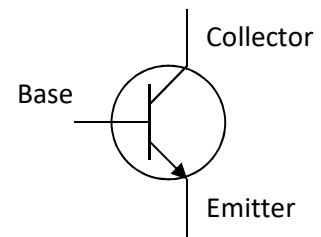

Operation

The transistor has three legs: the base, collector and the emitter. The emitter is usually connected to 0V and the electronics that is to be switched on is connected between the collector and the positive power supply (Fig A). A resistor is normally placed between the output of the Integrated Circuit (IC) and the base of the transistor to limit the current drawn through the IC output pin.

The base of the transistor is used to switch the transistor on and off. When the voltage on the base is less than 0.7V, it is switched off. If you imagine the transistor as a push to make switch, when the voltage on the base is less than 0.7V there is not enough force to close the switch and therefore no electricity can flow through it and the load (Fig B). When the voltage on the base is greater than 0.7V, this generates enough force to close the switch and turn it on. Electricity can now flow through it and the load (Fig C).

Fig A – Basic transistor circuit

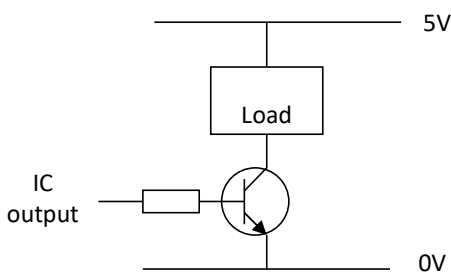

Fig B – Transistor turned off

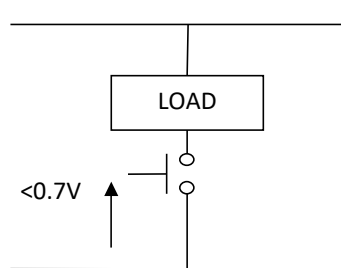
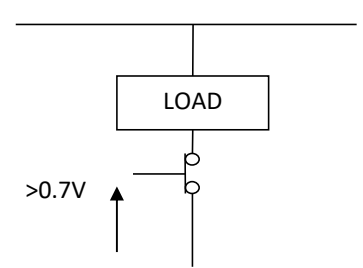
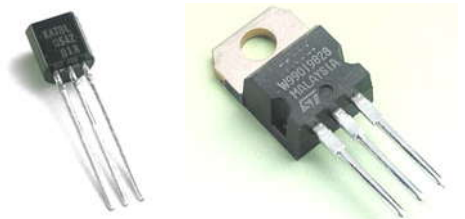

Fig C – Transistor turned on



Current rating

Different transistors have different current ratings. The style of the package also changes as the current rating goes up. Low current transistors come in a 'D' shaped plastic package, whilst the higher current transistors are produced in metal cans that can be bolted onto heat sinks so that they don't over heat. The 'D' shape or a tag on the metal can is used to work out which pin does what. All transistors are wired differently so they have to be looked up in a datasheet to find out which pin connects where.



Darlington Pair

What is a Darlington Pair?

A Darlington Pair is two transistors that act as a single transistor but with a much higher current gain.

What is current gain?

Transistors have a characteristic called 'current gain'. This is referred to as its h_{FE} .

The amount of current that can pass through the load when connected to a transistor that is turned on equals the **input current x the gain of the transistor (h_{FE})**.

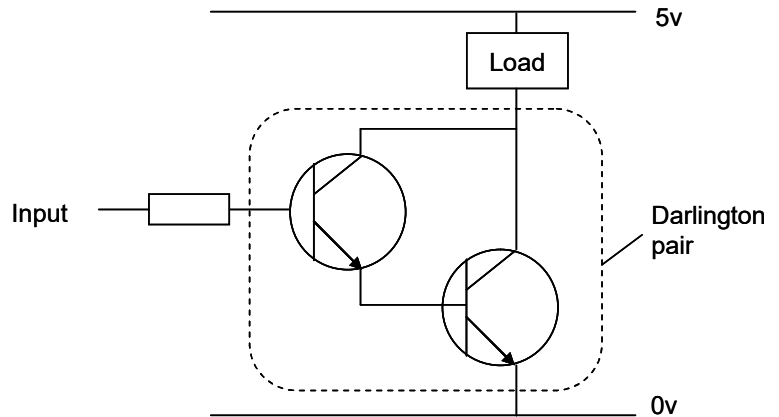

The current gain varies for different transistor and can be looked up in the datasheet for the device. Typically, it may be 100. This would mean that the current available to drive the load would be 100 times larger than the input to the transistor.

Why use a Darlington Pair?

In some applications, the amount of input current available to switch on a transistor is very low. This may mean that a single transistor may not be able to pass sufficient current required by the load.

As stated earlier, this equals the **input current x the gain of the transistor (h_{FE})**. If it is not possible to increase the input current, then we need to increase the gain of the transistor. This can be achieved by using a Darlington Pair.

A Darlington Pair acts as one transistor but with a current gain that equals:

Total current gain ($h_{FE \text{ total}}$) = current gain of transistor 1 ($h_{FE t1}$) x current gain of transistor 2 ($h_{FE t2}$)

So, for example, if you had two transistors with a current gain (h_{FE}) = 100:

$$(h_{FE \text{ total}}) = 100 \times 100$$

$$(h_{FE \text{ total}}) = 10,000$$

You can see that this gives a vastly increased current gain when compared to a single transistor. Therefore, this will allow a very low input current to switch a much larger load current.

Base activation voltage

In order to turn on a transistor, the base input voltage of the transistor will (normally) need to be greater than 0.7V. As two transistors are used in a Darlington Pair, this value is doubled. Therefore, the base voltage will need to be greater than $0.7V \times 2 = 1.4V$.

It is also worth noting that the voltage drop across the collector and emitter pins of the Darlington Pair when they turn on will be around 0.9V. Therefore if the supply voltage is 5V (as above) the voltage across the load will be will be around 4.1V ($5V - 0.9V$).



Instruction Manual

Your night light is going to be supplied with some instructions. Identify four points that must be included in the instructions and give a reason why.

Point to include:

Reason:

Point to include:

Reason:

Point to include:

Reason:

Point to include:

Reason:



Evaluation

It is always important to evaluate your design once it is complete. This will ensure that it has met all of the requirements defined in the specification. In turn, this should ensure that the design fulfils the design brief.

Check that your design meets all of the points listed in your specification.

Show your product to another person (in real life this person should be the kind of person at which the product is aimed). Get them to identify aspects of the design, which parts they like and aspects that they feel could be improved.

Good aspects of the design	Areas that could be improved

Improvements

Every product on the market is constantly subject to redesign and improvement. What aspects of your design do you feel you could improve? List the aspects that could be improved and where possible, draw a sketch showing the changes that you would make.



Packaging Design

If your product was to be sold in a high street electrical retailer, what requirements would the packaging have? List these giving the reason for the requirement.

Requirement	Reason

Develop a packaging design for your product that meets these requirements. Use additional pages if required.





ESSENTIAL INFORMATION

BUILD INSTRUCTIONS
CHECKING YOUR PCB & FAULT-FINDING
MECHANICAL DETAILS
HOW THE KIT WORKS

CREATE SOOTHING LIGHTING EFFECTS WITH THIS

DARK ACTIVATED COLOUR CHANGING NIGHT LIGHT KIT

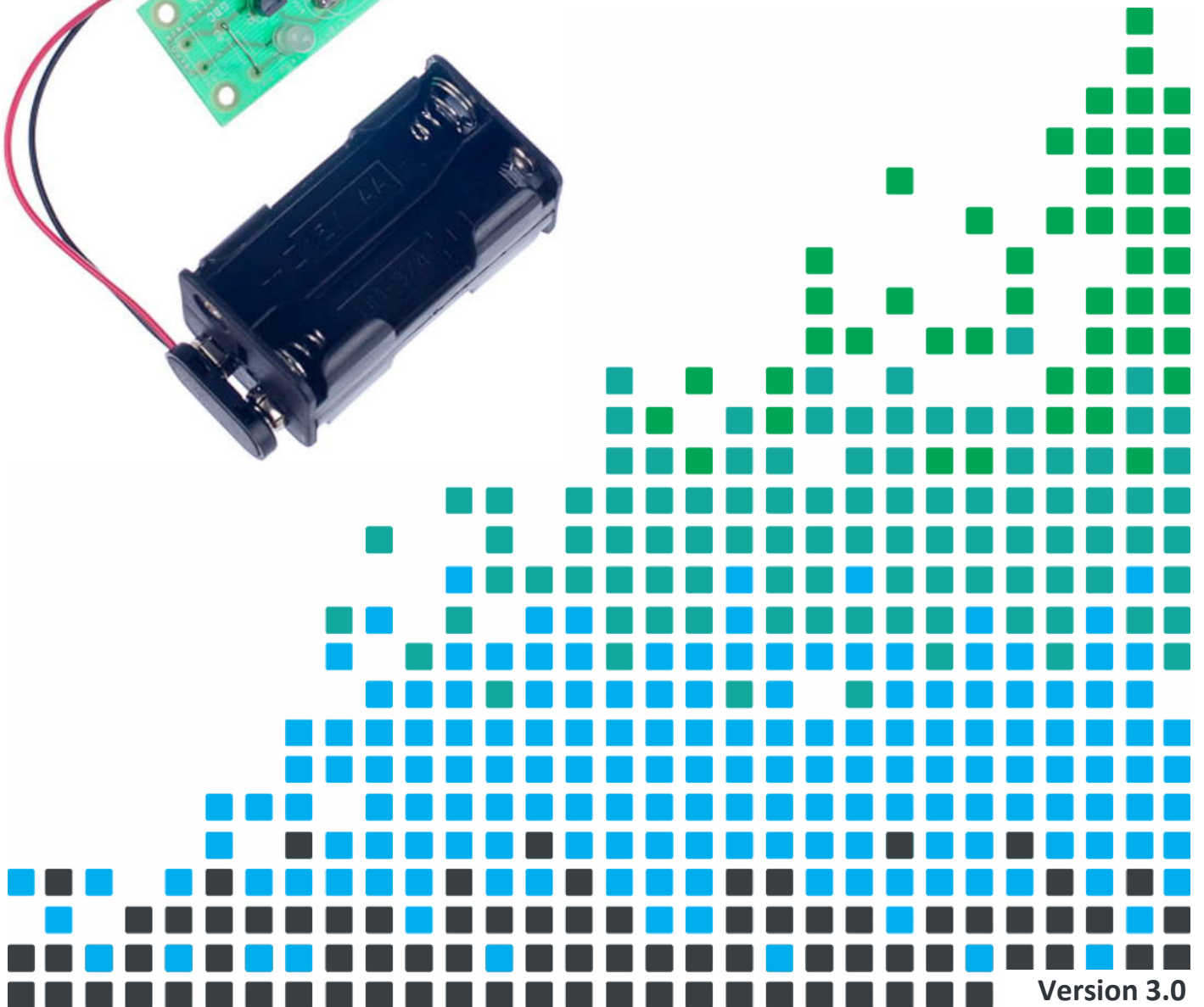
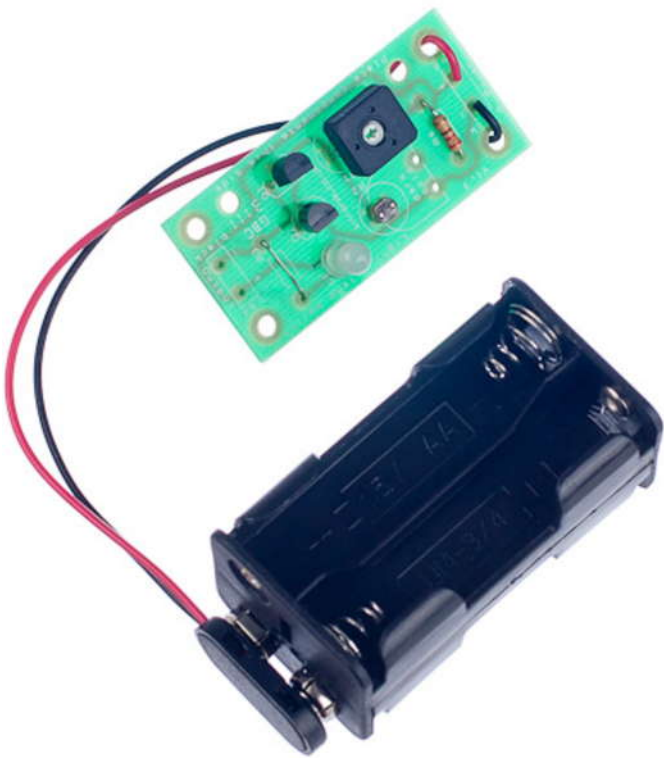

Version 3.0

Build Instructions

Before you start, take a look at the Printed Circuit Board (PCB). The components go in the side with the writing on and the solder goes on the side with the tracks and silver pads.

1 PLACE THE RESISTOR

Start with the 220Ω resistor, which has red, red, brown coloured bands. Solder this resistor into the board where it is labelled R4.



2 PLACE THE TRANSISTORS

Place the two transistors into the board where it is labelled Q1 and Q2. It is important that they are inserted in the correct orientation. Ensure that the shape of the device matches the outline printed on the PCB. Once you are happy, solder the devices into place.

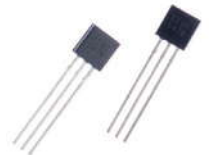

3 SOLDER THE VARIABLE RESISTOR

Solder the variable resistor into R1. It will only fit in the holes in the board when it is the correct way around.



4 SOLDER THE PHOTODETECTOR

Solder the Photodetector into the circle indicated by the text R2. This is next to the 'dark' text. For the phototransistor make sure the flat edge is towards the Output connections end of the PCB. If you have an LDR it does not matter which way around it is inserted.



Phototransistor LDR

5 ADD A WIRE LINK

The colour changing LED used in this kit doesn't need a current limit resistor as it is a 5V LED. **Therefore we need to add a wire link.** Take a piece of wire (the lead you have just cut off another component is perfect) and solder it into the board where it is marked R3.

6 SOLDER THE LED

Solder the Light Emitting Diode into LED1. The LED won't work if it doesn't go in the right way around. If you look carefully one side of the LED has a flat edge, which must line up with the flat edge on the lines on the PCB.



Now you must attach the battery clip. It needs to be connected to the terminals marked 'Power'.

7 ATTACH THE BATTERY CLIP

The red lead should be soldered to the '+' terminal also marked 'red' and the black lead should be soldered to the '-' terminal also marked 'black'.



Checking Your Night Light PCB

Check the following before you connect power to the board:

Check the bottom of the board to ensure that:

- All these leads are soldered.
- Pins next to each other are not soldered together.

Check the top of the board to ensure that:

- The body of the two transistors matches the outline on the PCB.
- The flat edge on the LED lines matches the outline on the PCB.
- The flat edge on the Phototransistor is towards the Output connections end of the PCB
- The power clip is attached where it is marked 'Power'.
- The red wire on the power clip goes to the connection marked 'red' and the black wire to the connection marked 'black'.

Testing the PCB

You might need to adjust the variable resistor R1. It won't be far wrong if you start with the resistor pointing at the middle of the text 'components'.

- When the sensor is covered (so that it is dark) the LED should be on.
- When the sensor is light the LED should be off.

If this is not the case, recheck your board following the instructions at the top of this page.



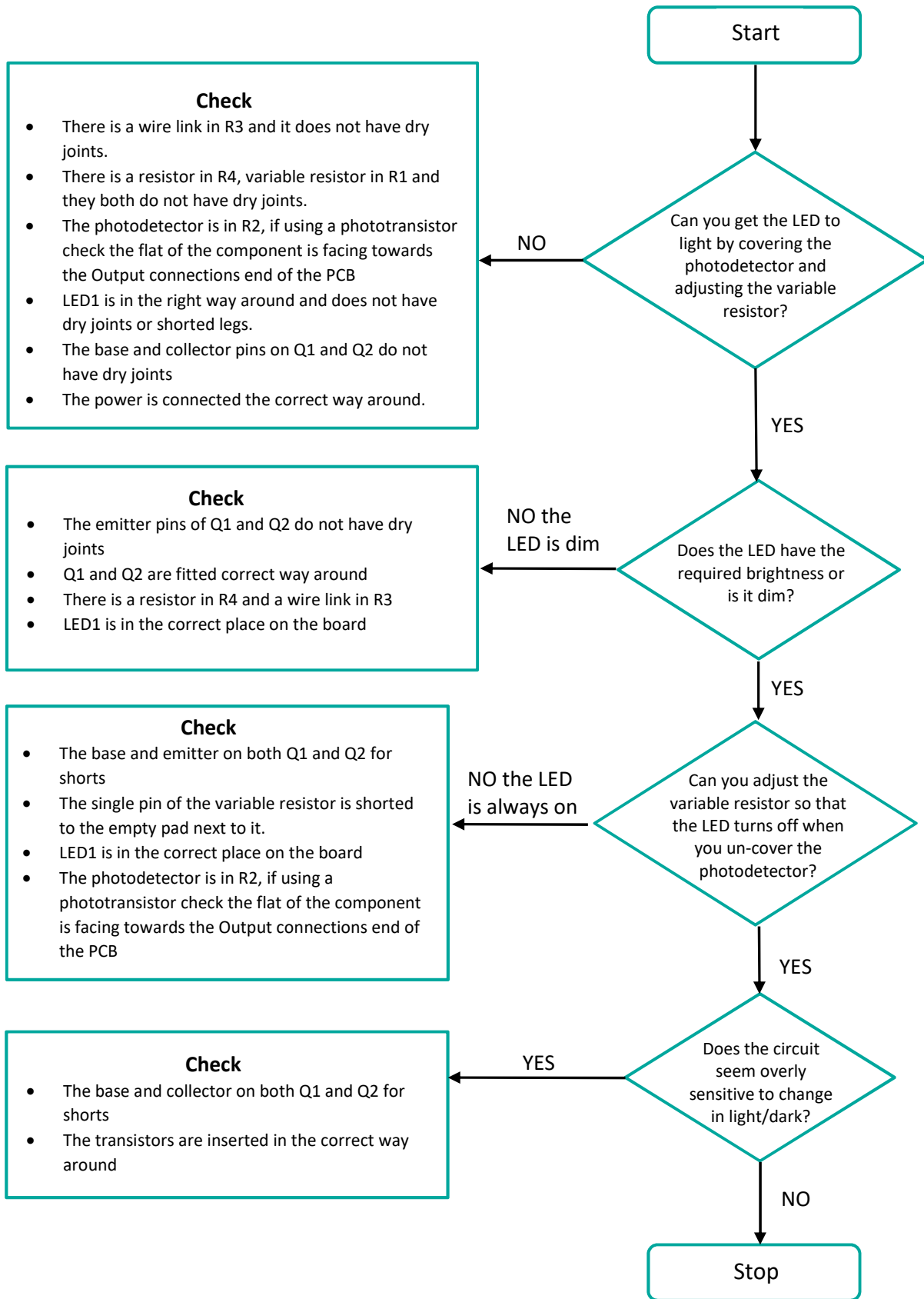

Designing the Enclosure

When you design the enclosure, you will need to consider:

- The size of the PCB (below left).
- How big the batteries are (right).

These technical drawings of the PCB and battery holder should help you to plan this.

All dimensions in mm
x4 holes 3.3mm diameter

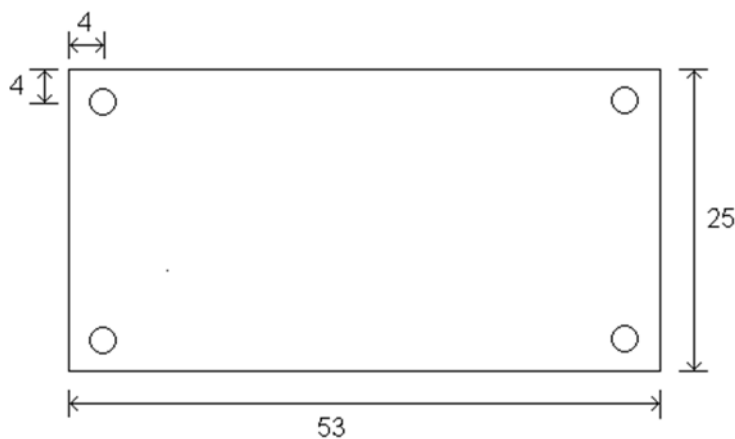
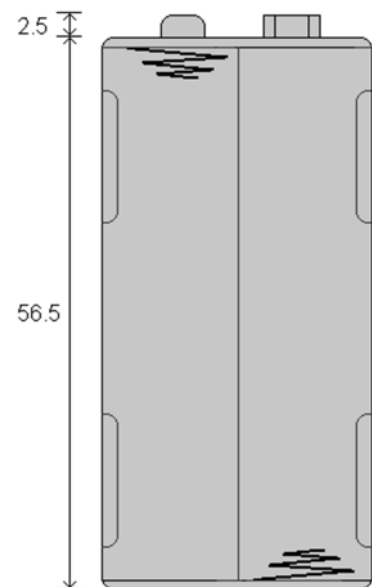
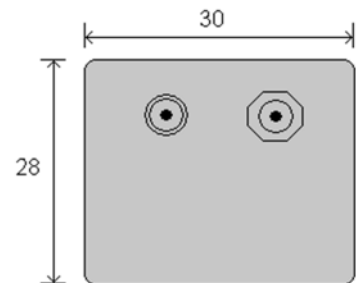

	<p>Mounting the PCB to the enclosure</p> <p>The drawing to the left shows how a hex spacer can be used with two bolts to fix the PCB to the enclosure.</p> <p><i>Your PCB has four mounting holes designed to take M3 bolts.</i></p>
--	---



How the Dark Activated Switch Works

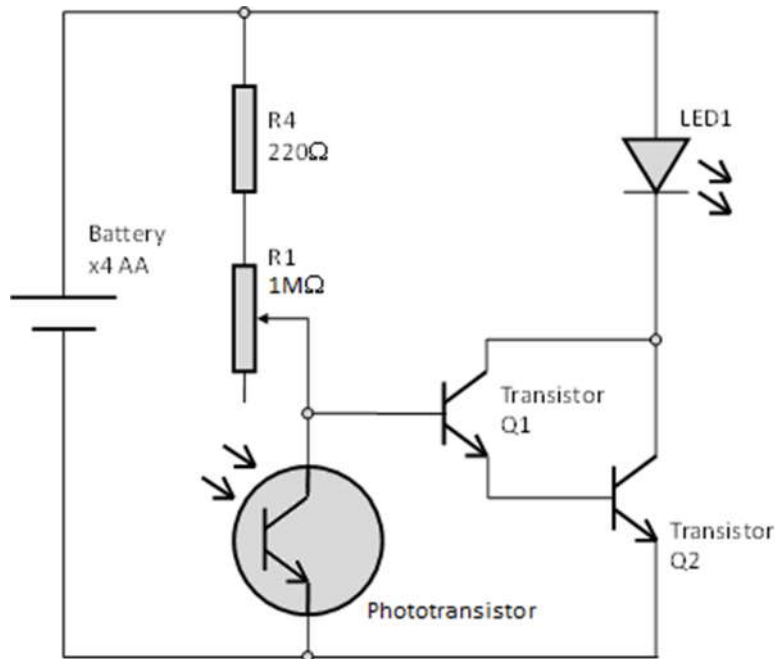

The circuit operation is very simple. When the input to the transistor Q1, which is fed from the connecting point of R1 and the Phototransistor, is greater than 1.4V, the output is turned on. Normally it requires 0.7V to turn on a transistor but this circuit uses two transistors in a Darlington Pair, meaning that it requires $2 \times 0.7V = 1.4V$ to turn on both transistors.

When the Phototransistor detects a brighter light level it conducts. Current flows through the component down to ground, thus pulling the voltage down at the transistor and turning it off.

When the phototransistor detects a darker light level, the phototransistor conducts less, so that the voltage at Q1 is pulled towards the supply voltage by the resistor R1 and R4. When this voltage is at 1.4V or higher transistor Q1 turns on.

R4 is present to protect the transistor Q1 should the variable resistor be set to zero.

It is also worth noting that the output, when turned on, will be around 0.9V lower than the supply voltage V+. This is because of the voltage drop across the collector and emitter pins of the Darlington Pair of transistors. Therefore if the supply voltage is 5V, then the output voltage will be around 4.1V.

Adjusting the trigger level

The point at which the circuit is triggered is set by the 1MΩ variable resistor. By varying the value of this resistor, the ratio of current flow of R1 and the phototransistor can be varied to a point where a centre voltage (trip point) of 1.4V is achieved at the desired light level.

LED

When the board switches on the output, the LED will turn on. With a normal LED you would need a resistor to limit the current flowing into the LED to ensure that it isn't damaged and to control the brightness. This would be resistor R3. With the colour changing LED, this is built into the LED itself. This is why when you built the kit, R3 has been replaced with a simple wire link.



Online Information

Two sets of information can be downloaded from the product page where the kit can also be reordered from. The 'Essential Information' contains all of the information that you need to get started with the kit and the 'Teaching Resources' contains more information on soldering, components used in the kit, educational schemes of work and so on and also includes the essentials. Download from:

www.kitronik.co.uk/2120



This kit is designed and manufactured in the UK by Kitronik

Telephone: +44 (0) 845 8380781

Sales email: sales@kitronik.co.uk

Tech support email: support@kitronik.co.uk

Web: www.kitronik.co.uk



www.kitronik.co.uk/twitter



www.kitronik.co.uk/facebook



www.kitronik.co.uk/youtube



www.kitronik.co.uk/google

Every effort has been made to ensure that these notes are correct, however Kitronik accept no responsibility for issues arising from errors / omissions in the notes.

© Kitronik Ltd - Any unauthorised copying / duplication of this booklet or part thereof for purposes except for use with Kitronik project kits is not allowed without Kitronik's prior consent.

