

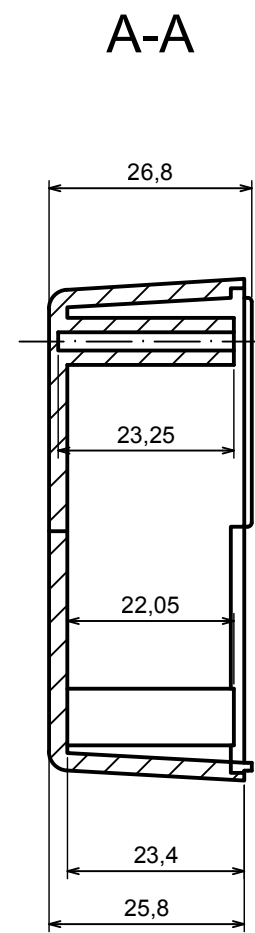

All rights reserved, Copyright Kradox 2017		
Product model	Enclosure Z24B - Assembly	
Format: A3	Material: PS, ABS	
Scale 1:1	Tolerance: +/- 0.8	

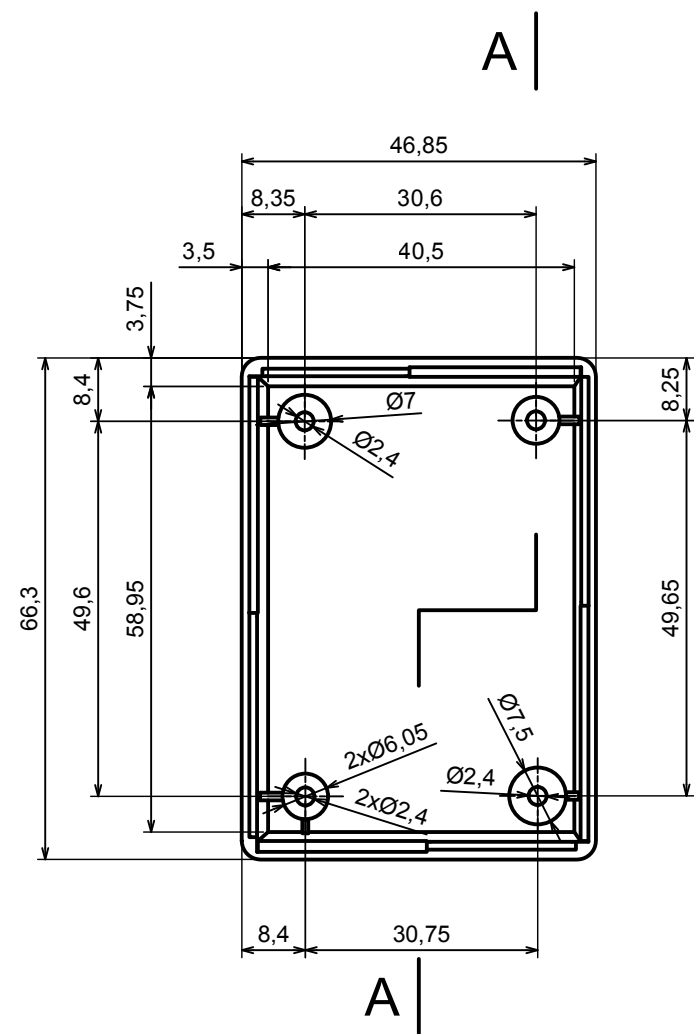

All rights reserved, Copyright Kradox 2017		
Product model	Enclosure Z24B - Base / Cover	
Format: A3	Material: PS, ABS	
Scale 1:1	Tolerance: +/- 0.8	