

BLTouch: Auto Bed Leveling Sensor for 3D Printers

Smart V3.1 Highlights

Logic Voltage Free(Open Drain Output): 3.3V / 5V The desired output logic voltage is stored in the EEPROM of the probe and can be selected by commands.

Long Stroke: The stroke is up to 1.6mm longer than V2.0

Z trigger with adaptable width: The Z trigger pulse with adaptable width beyond 10ms eliminates the danger of firmware missing the trigger and the nozzle reaching the bed.

Smart V2.0 and later versions highlights

Blue & Red LED: Blue (Duty 3~11%: normal PWM signal and Zmin signal) and Red (Duty 80%: abnormal Power) LED for checking wiring defects.

Engineering plastic Push-pin: Engineering plastic push-pin can be bent more easily than aluminum pins so that engineering plastic push-pin can be recovered well and the 3D printer can be protected.

BLTouch – Smart V3.1

| BLTouch Instruction | Center Of PWM (Available PWM Range ±20) | G-code x: Servo Pin or No. | | |
|--|--|----------------------------|---------------|--------------|
| | | Marlin / Duet | Repetier | Smoothieware |
| Push-pin Down (deploy) | 647 μ s (10°) | M280 Px S10 | M340 Px S647 | M280 S3.24 |
| Alarm Release & Touch SW Mode(M119) | 1162 μ s (60°) | M280 Px S60 | M340 Px S1162 | M280 S5.81 |
| Push-pin Up (Stow) | 1473 μ s (90°) | M280 Px S90 | M340 Px S1473 | M280 S7.36 |
| Self-test (10 Times) | 1782 μ s (120°) | M280 Px S120 | M340 Px S1782 | M280 S8.9 |
| EEPROM Conversion Request | 1884 μ s (130°) | M280 Px S130 | M340 Px S1884 | M280 S9.42 |
| EEPROM::5V Logic Zmin (Do not activate on 3.3V logic system) | 1988 μ s (140°) | M280 Px S140 | M340 Px S1988 | M280 S9.94 |
| EEPROM::Logic voltage Free Zmin (Return to default: Open Drain) | 2091 μ s (150°) | M280 Px S150 | M340 Px S2091 | M280 S10.45 |
| Alarm Release & Push-pin UP | 2194 μ s (160°) | M280 Px S160 | M340 Px S2194 | M280 S10.97 |

※ Depending on your board, you can need to adjust the PWM range or Duty cycle.

※ EEPROM::5V Logic Zmin: Used with 130° when the Z probe input pin on the control board is not pull-up or has an abnormal input circuit.

☞ see Logic Voltage Conversion

Specification

| | |
|---------------------------------------|---|
| Voltage / Current | 4.8 ~ 5.1 V |
| Current | 15mA |
| Maximum (Peak) | 300mA |
| Z Probe Output Open Drain VDS / ID | Logic Free (Open Drain: default) or 5V logic Max VDS = 5V / Max ID = 300mA |
| PCB / Soldering | OSP / Lead Free |
| Cable Length | 150±5 mm (for retail) |
| Weight | 0.35oz (10g) |
| Wiring | 3Pin: Brown (GND), Red (+5V) Orange (control signal) 2Pin: Black (GND) White (Zmin) |
| Case & Push-pin | Polycarbonate (PC) |

BLTouch CAD Dimension

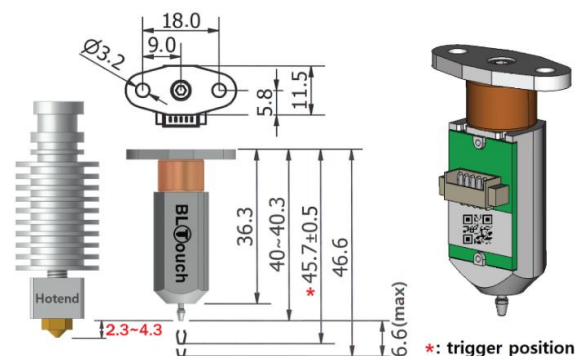

※ An additional power supply may be needed in case your board does not supply enough current at 5V.

※ Electronic devices can be damaged or even destroyed if connected to the wrong side polarity.

※ Set Zmin pull-up on your firmware when using Logic Free (In most cases, it is already set up)

※ If push-pin deploy fails, turn the core by up to 180 degrees with an Allen-key so that the core is further inside the casing.

※ Depending on your type of 3D printer, you may need to remove or add some parts to the controller board.

※ In principle, a controller board with a large capacitor in the end stop input circuit is not supported. (You may need to remove such a capacitor from your board)

※ If noise, etc. interference is expected, you should use an anti-interference extension cable (Shielded or Twisted Cable).

※ Selling price and specifications are subject to change without prior notice.

■ Timing Diagram

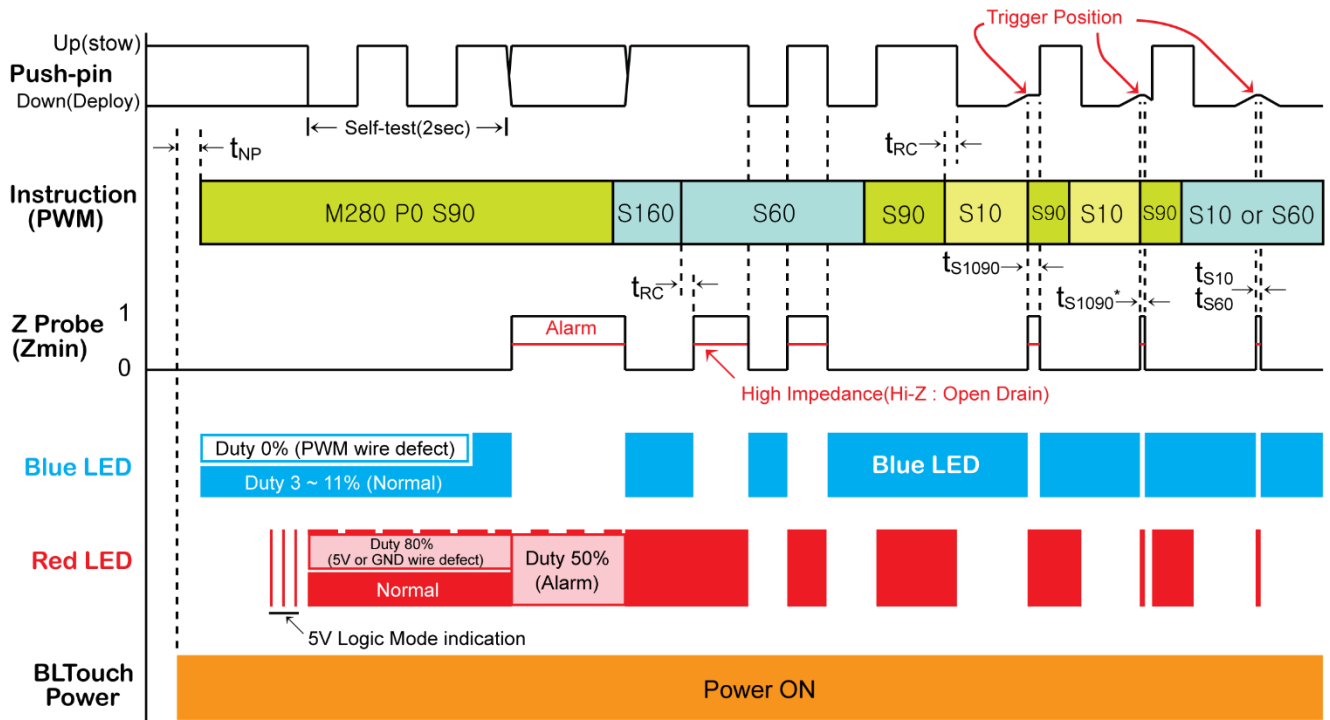

t_{RC} : Read Cycle Time (min=60ms) t_{NP} : Non-PWM Time for checking power wiring defects (min=100ms)
 t_{S10} : Trigger pulse Time of probing using S10 (647 μ s) t_{S60} : Trigger pulse Time of probing using S60 (1162 μ s)
 t_{S1090} / t_{S1090^*} : Trigger pulse Time of probing using S10 (647 μ s) and S90 (1473 μ s)

t_{S10} : 1 ~ 10ms (Time depends on the 3D printer board), max = ≤ 620 ms, Alarm

t_{S60} : 1 ~ 10ms (Time depends on the 3D printer board), max = ∞

t_{S1090} : 40 ~ 150ms, max = 650ms, Alarm

t_{S1090^*} : 1 ~ 10ms (Time depends on the 3D printer board), max = 650ms, Alarm

t_{NP} : If a 5V or GND wiring defect occurs during printing, the red LED flashes at 80% duty. Please check the 5V or GND line.

■ Probing

Probing with Push-pin Down (M280 P0 S10) : t_{S1090} / t_{S1090^*} :

- Step 1 : Push-pin Down (M280 P0 S10)
- Step 2 : Probing (keep M280 P0 S10)
- Step 3 : Push-pin Up (M280 P0 S90) after triggered
- Caution: An alarm may occur.

Probing with Push-pin Down (M280 P0 S10) : t_{S10} ← Recommended

- Step 1 : Push-pin Down (M280 P0 S10)
- Step 2 : Probing (keep M280 P0 S10)
- Step 3 : After triggered, if probing is not finished yet, go Step 2.
- Step 4 : Push-pin Up (M280 P0 S90)
- Caution: An alarm may occur.

Probing with Touch Switch Mode (M280 P0 S60) : t_{S60}











- Step 1 : Push-pin Down (M280 P0 S10)
- Step 2 : Touch Switch Mode (M280 P0 S60)
- Step 3 : Probing (keep M280 P0 S60)
- Step 4 : After triggered, if probing is not finished yet, go Step 3.
- Step 5 : Push-pin Up (M280 P0 S90)
- Caution: The push pin may not be completely down.

Probing with Touch Switch Mode (M280 P0 S60) : t_{S60} ← Recommended

- Step 1 : Push-pin Down (M280 P0 S10)
- Step 2 : Touch Switch Mode (M280 P0 S60)
- Step 3 : Probing (keep M280 P0 S60)
- Step 4 : After triggered, if probing is not finished yet, go Step 1.
- Step 5 : Push-pin Up (M280 P0 S90)

Wiring

Soldering and firmware update might be needed in rare case

| | | |
|---|---|---|
|  | I can find a servo pin on my board.  click here RAMPS1.3/1.4, MKS-Gen V1.3, MKS-Base V1.4, etc. |  |
| | I can not find any Servo pin on my board.  click here MKS-Base V1.2, mini-Rambo, etc. |  |
| | I can not find Servo Pin on my board and  click here #define SERVO0_PIN is not included in pins_YourMotherboard.h. (Sanguinololu1.3a, Melzi, Ender-3, Anet, FlashForge, Azteeg X3, etc.) ※ Depending on your type of 3D printer, you may need to remove or add some parts of the board. |  |
| | 32bit board  click here Smoothieboard, MKS-Sbase, BBP1S, Alligator, AZSMZ, STEVAL-3DP001V1, Duet, etc. |  |
| | Logic Voltage Conversion (writing to EEPROM) |  |

■ Open Drain for Logic Voltage Free

In the BLTouch, an additional MOSFET is used to implement the Logic Free 3.3V / 5V (Open Drain) output mode.

Open Drain(Default) mode depends on the logic level of your control board, so if your board is a 5V logic system, BLTouch operates in 5V logic mode and 3.3V logic mode if your board is a 3.3V logic system.

Other than some special cases (for example, a controller board that has a Zmin input with a large capacitance), the Smart V3 is a drop-in replacement for a V2 (no firmware modification needed).

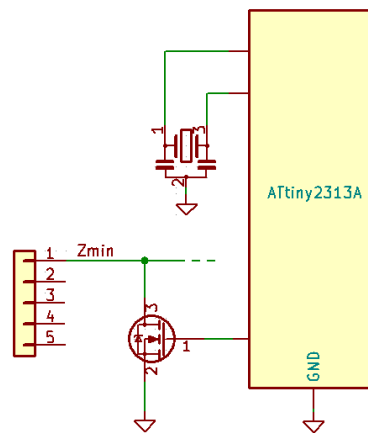

■ Correct position of Core (V3.x)

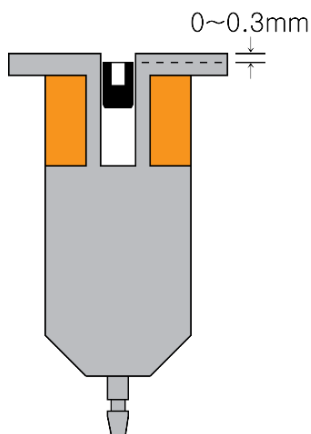

■ Slic3r

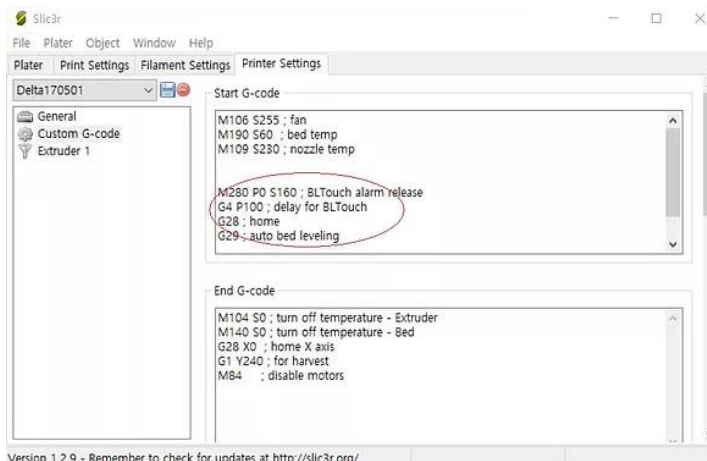

■ Logic Voltage Conversion (writing to EEPROM)

In most cases, this operation is not required. **We recommend that you do not set this up if possible.** If necessary, you can set the logic voltage in one of two ways:

1. The Z probe input pin on the control board is not pull-up or has an abnormal input circuit. (A board with a large capacity capacitor in the end-stop input circuit, such as the Melzi)

- ☞ And if the nozzle is in contact with the bed after missing the trigger signal
- ☞ If you want more precision bed leveling, Remove the capacitor(recommended).
- ☞ This setting is not required if the large capacity capacitor has already been removed from the board.
- ☞ Do not activate 5V logic on the 3.3V logic system without 3.3V logic conversion.

Step 1: Connect the 3pin (brown, red, orange) and 2pin (black, white) to the control board.

Step 2: M280 P0 S10 ← least 500ms

Step 3: M280 P0 S140 ← least 150ms

Step 4: M280 P0 S130 ← least 150ms

Step 5: M280 P0 S140 ← least 150ms

Step 6: Check if there is a 5V Logic Mode indication.

If no 5V Logic Mode Indication is found, perform Steps 2 to Step 5 again.

2. Return to default (Logic voltage free) mode

- ☞ This operation is not necessary if you have not previously set it to 5v Logic.

Step 1: If your control board is a 3.3V Logic system, connect 3 pin to the control board without 2pin connections.

Step 2: M280 P0 S10 ← least 500ms

Step 3: M280 P0 S150 ← least 150ms

Step 4: M280 P0 S130 ← least 150ms

Step 5: M280 P0 S150 ← least 150ms

Step 6: Check if there is a 5V Logic Mode indication. The 5V Logic Mode Indication should no longer appear.

The 5V Logic can damage the 3.3V Logic system.

If there is a 5V Logic Mode Indication, perform Step2 to Step5 again.

Step 7: Connect the 2pin to the control board

5V Logic Mode Indication: ☞ see Timing Diagram

When the BLTouch is disconnected and re-connected, the red LED flashes at 10ms length 3 times immediately.

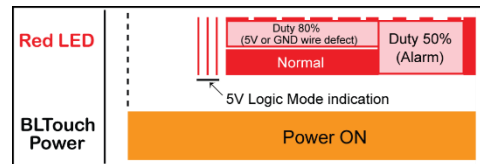

Handshake:

When each EEPROM command (S130, S140, S150) is completed, the 10ms red LED is turned on once or twice.

The last command for mode conversion (S140 or S150) will be activated immediately and the 10ms red LED flashes two times.

Please don't mix up the sequence.

If the correct order and minimum retention time are not observed, a retry may be required.

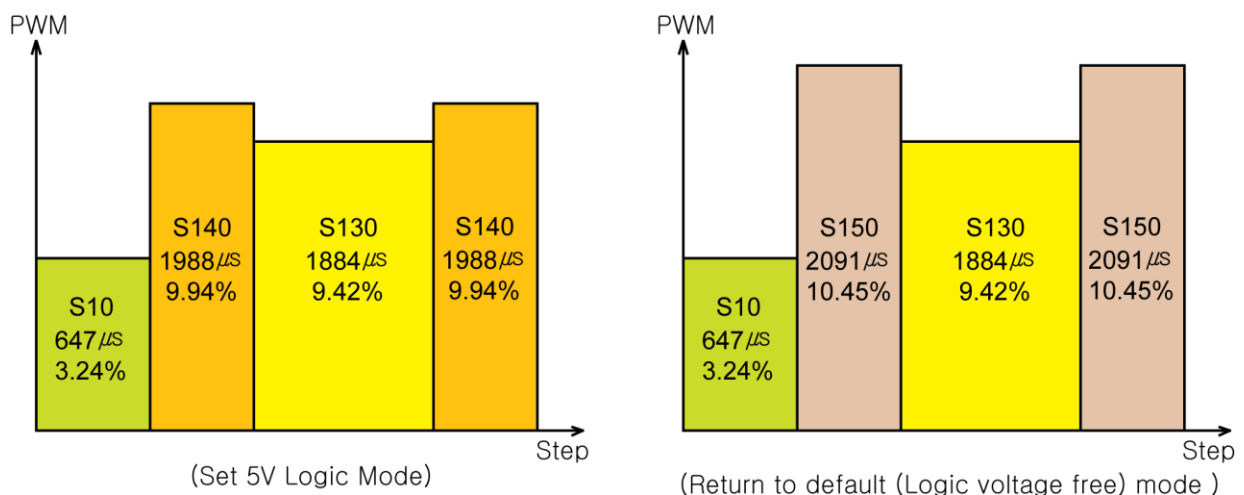

Logic voltage (EEPROM) is not changed until a new setting is completed.

■ Setting (e.g. Marlin firmware)

Please update the firmware in the following order:

Step 1: Copy the file below and overwrite at the Marlin folder. <== e.g. default

Marlin-bugfix-2.0.x\config\default\Configuration.h

Marlin-bugfix-2.0.x\config\default\Configuration_adv.h

Step 2: Look at the Configuration.h at your previous firmware and edit Configuration.h at Marlin.

Step 3: Check your 3D printer works well.

Step 4: Please install your BLTouch.

Step 5: Edit Configuration.h and Configuration_adv.h like below.

Marlin-bugfix-2.0.x Setting

<https://github.com/MarlinFirmware/Marlin/archive/bugfix-2.0.x.zip>

■ Configuration.h

```
//===== Endstop Settings =====
#define USE_ZMIN_PLUG // a Z probe
#define ENDSTOPPULLUPS
#define ENDSTOP_INTERRUPTS_FEATURE

//===== Z Probe Options =====
#define Z_MIN_PROBE_USES_Z_MIN_ENDSTOP_PIN

#define BLTOUCH
#if ENABLED(BLTOUCH)
  // #define BLTOUCH_DELAY 500 // *option
  // #define BLTOUCH_FORCE_5V_MODE
#endif

#define PROBING_HEATERS_OFF // *option
#define PROBING_FANS_OFF // *option
#define X_PROBE_OFFSET_FROM_EXTRUDER 0 // Depend on your BLTouch installation value
#define Y_PROBE_OFFSET_FROM_EXTRUDER -22 // Depend on your BLTouch installation value
#define Z_PROBE_OFFSET_FROM_EXTRUDER -2.35 // Depend on your BLTouch installation value

// It must be greater than or equal to the higher of the X_PROBE_OFFSET_FROM_EXTRUDER and Y_PROBE_OFFSET_FROM_EXTRUDER.
#define MIN_PROBE_EDGE 22

#define Z_PROBE_SPEED_FAST HOMING_FEEDRATE_Z / 5
#define Z_CLEARANCE_DEPLOY_PROBE 15 // set up at least 10
#define Z_CLEARANCE_BETWEEN_PROBES 5 // set up at least 5

//===== Bed Leveling =====
#define AUTO_BED_LEVELING_BILINEAR // *option
```